

Panasonic Broadcast Mechanical Parts List

MODEL: BT-LH1700WP,E,MC / BT-YAE1700G

Note:

1. *Be sure to make your orders of replacement parts according to this list.
2. Unless otherwise specified, all resistors are in OHMS, K=1,000 OHMS, all capacitors are in MICROFARADS (μ F), P= μ μ F.
3. The P.C. Board unit marked with "■" shown below the main assembled parts.
4. The parts marked with $\text{\textcircled{E}}$ on the exploded view show the electric parts.
5. IMPORTANT SAFETY NOTICE
Components identified with the mark Δ have the special characteristics for safety. When replacing any of these components, use only the same type.
6. The marking (RTL) indicates the retention time is limited for this item.
After the discontinuation of this assembly in production, it will no longer be available.
7. "M" in Remark column indicates needed in the periodical maintenance.

CONTENTS

BT-LH1700WP,E,MC

CASING PARTS ASSEMBLYMPL-1

PACKING PARTSMPL-3

ELECTRICAL REPLACEMENT PARTS LISTEPL-1

BT-YAE1700G

CASING PARTS ASSEMBLY (BT-YAE1700G).....MPL-1

PACKING PARTS (BT-YAE1700G).....MPL-3

CASING PARTS ASSEMBLY

Components identified with the mark \triangle have the special characteristics for safety. When replacing any of these components, use only the same type.

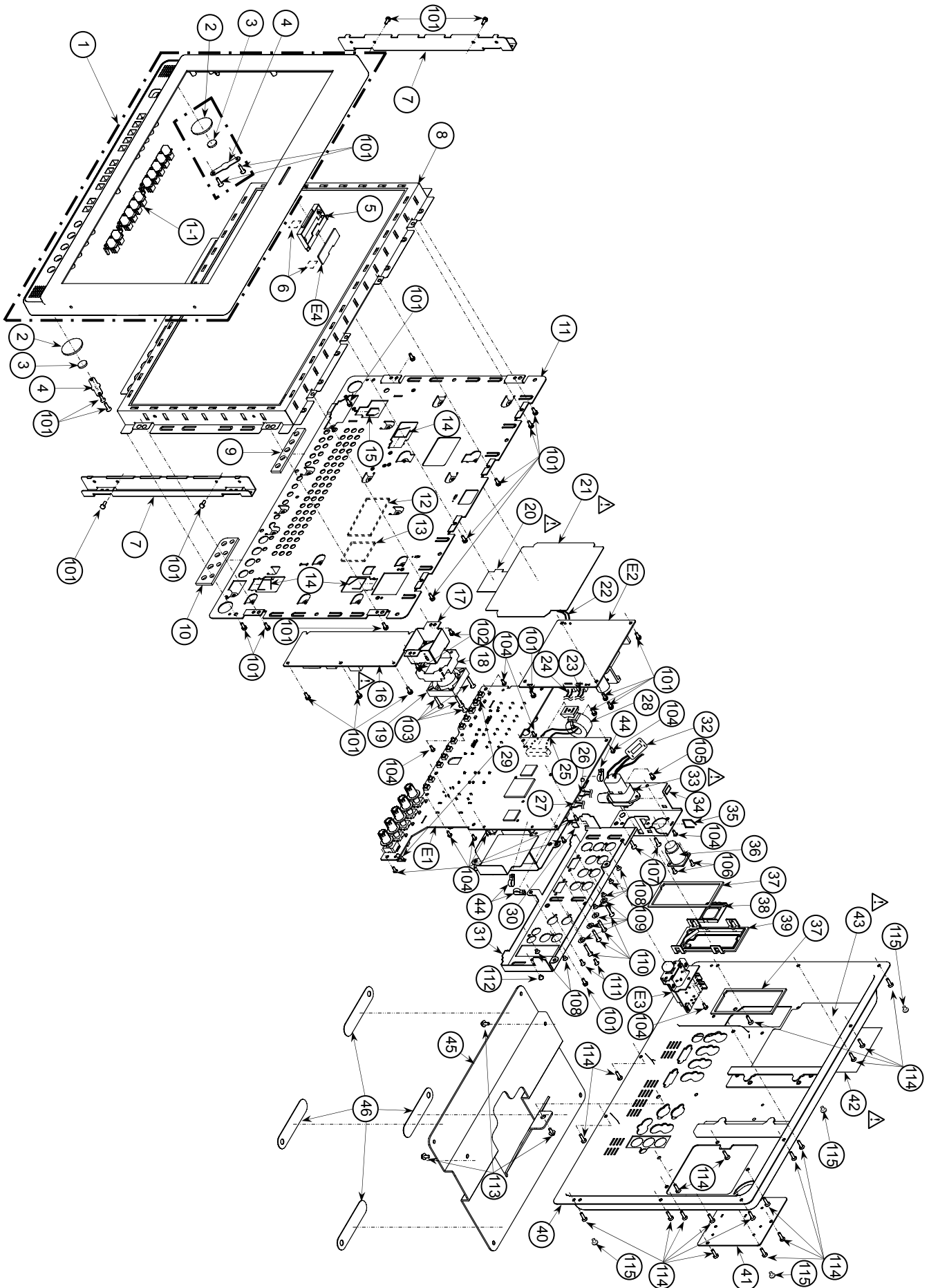

PACKING PARTS

Components identified with the mark  have the special characteristics for safety. When replacing any of these components, use only the same type.

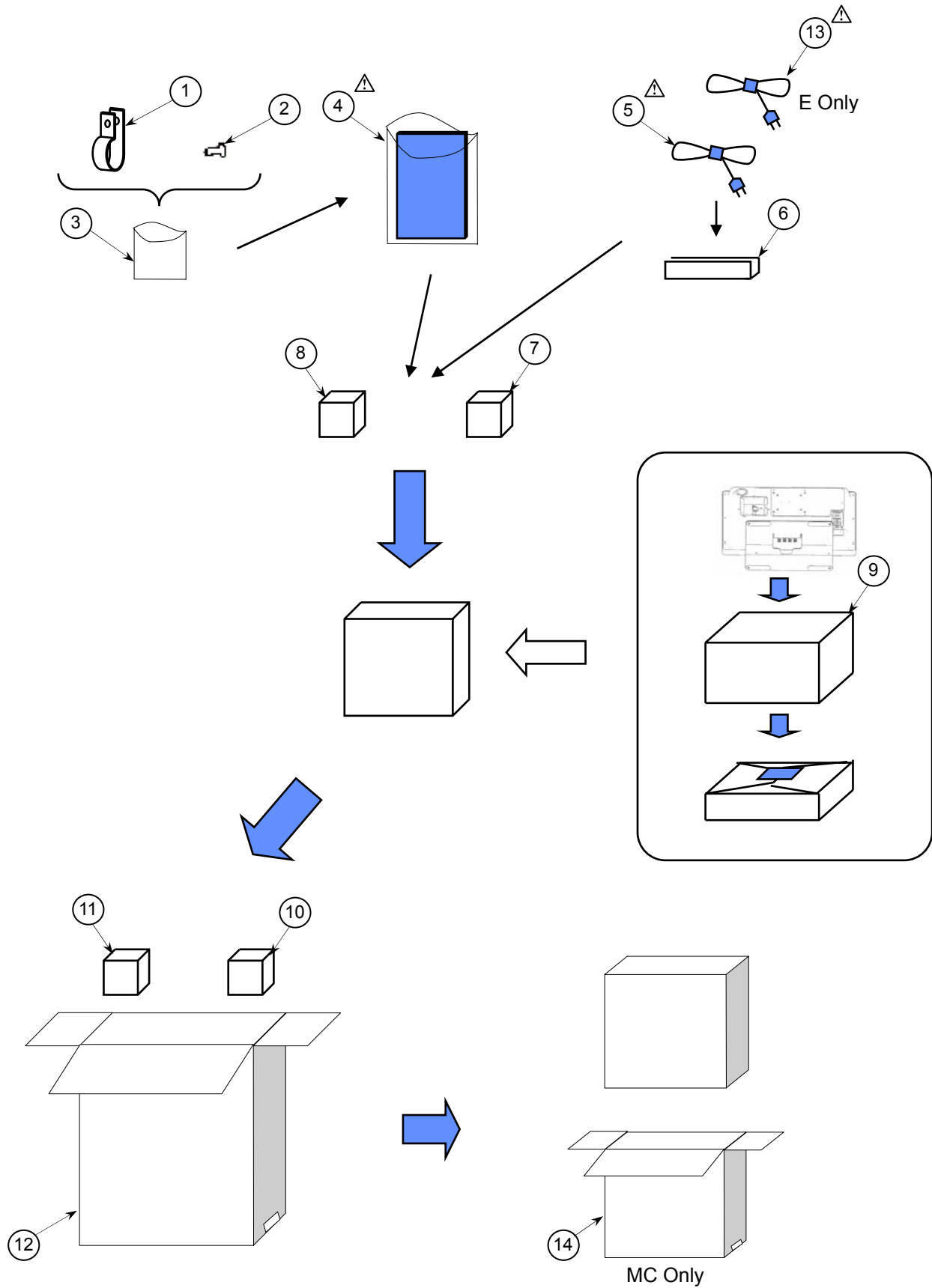

Ref.No.	Part No.	Part Name & Description	Pcs	Remarks
IC1004	CODBAJH00014	IC	1	
IC1005	COBBBA000022	IC	1	
IC1006	BA9743AFV	IC	1	CODBAZC00010
IC1007	CODBZH00001	IC	1	
IC1008	COBBBA000022	IC	1	
IC1009	COABBA000075	IC	1	
IC1010	CODBZZ00047	IC	1	
IC1011	CODBZH00012	IC	1	
IC1200	NJM431U	IC	1	CODBEZC00003
IC2000	COJBAQ000174	IC	1	
IC2001-03	COJBAZ001935	IC	3	
IC2100	COJBAR000421	IC	1	
IC2101	COABBB000220	IC	1	
IC2102, 03	C1BB00000840	IC	2	
IC2104	COABBB000220	IC	1	
IC3000	CODBZZ00047	IC	1	
IC3001-03	COABGB000027	IC	3	
IC3004	COCBBC00157	IC	1	
IC3005-14	COJBAR000432	IC	10	
IC3015	COCBAYF00018	IC	1	
IC3200	CODBZZ00047	IC	1	
IC3201	COCBBC00157	IC	1	
IC3202	COJBAR000432	IC	1	
IC3203	COABGB000027	IC	1	
IC3204, 05	COJBAB000629	IC	2	
IC3206	COABGB000027	IC	1	
IC3207-13	COJBAR000432	IC	7	
IC3214	COCBAC00231	IC	1	
IC3215	COCBBC000029	IC	1	
IC3216	COJBAB000407	IC	1	
IC3217	COCBAC00231	IC	1	
IC3218	C1AB00002385	IC	1	
IC3219	COJBAZ001120	IC	1	
IC3220, 21	COJBAQ000174	IC	2	
IC3300, 01	CODBZZ00047	IC	2	
IC3302-07	COABGB000027	IC	6	
IC3308	COCBBC00157	IC	1	
IC3309	C1AB00002172	IC	1	
IC3400	COCBBC00157	IC	1	
IC3401	C1AB00002206	IC	1	
IC3402	C1AB00002207	IC	1	
IC3403, 04	COCBAYF00018	IC	2	
IC3405	COJBAZ001591	IC	1	
IC6000	C2DBYK000005	IC	1	
IC6001	CODBZF000018	IC	1	
IC6002	C3ABPG000145	IC	1	
IC6003	COEBH0000497	IC	1	
IC6005	C3EBJC000055	IC	1	
IC6006	VEF0018C	IC	1	
IC6007	COFBD000148	IC	1	
IC6008-12	COJBA0000632	IC	5	
IC6100	COZBZ0001160	IC	1	
IC6103	COABBA000075	IC	1	
IC6200	C1ZBZ0002561	IC	1	
IC6300	MN845110-A	IC	1	
IC6301	C3ABQJ000031	IC	1	
IC6302	C1ZBZ0002577	IC	1	
IC6303	CODBEFH00001	IC	1	
IC6305	CODBEZG00018	IC	1	
IC6500	C1ZBZ0002561	IC	1	
IC6501	C3ABPJ000071	IC	1	
IC6600	COJBCZ000512	IC	1	
J1200	K4CD01000016	TERMINAL	1	
J1205	K4CD01000016	TERMINAL	1	
J2100	K2HA204A0042	JACK	1	
J3000-02	K1QBB2AA0004	CONNECTOR (FEMALE)	3	
J3003	K1QBB3AA0004	CONNECTOR (FEMALE)	1	
J3300	K1QBB2AA0004	CONNECTOR (FEMALE)	1	
J3301, 02	K1CB104H0003	CONNECTOR (FEMALE)	2	
J3400-02	K1QBB1BA0012	CONNECTOR (FEMALE)	3	
L1000	G1A100G00014	COIL	10UH	1
L1001	JOJBC0000019	FILTER		1
L1002	G1C150M00015	COIL	15UH	1

Ref.No.	Part No.	Part Name & Description	Pcs	Remarks
L1003	JOJBC0000019	FILTER		1
L1004	G1A3R3HA0020	COIL	3.3UH	1
L1005	G1A100G00014	COIL	10UH	1
L1006, 07	JOJBC0000019	FILTER		2
L1008	G1C220M00032	COIL	22UH	1
L1009	G1A3R3HA0020	COIL	3.3UH	1
L1010	G1A100G00014	COIL	10UH	1
L1011, 12	JOJBC0000019	FILTER		2
L1013	G1C330M00015	COIL	33UH	1
L1014	G1A4R7HA0019	COIL	4.7UH	1
L1015	JOJBC0000019	FILTER		1
L1016	G1A100G00014	COIL	10UH	1
L1017-19	JOJBC0000009	FILTER		3
L1020	G1A100G00014	COIL	10UH	1
L200, 01	JOJBC0000009	FILTER		2
L2000, 01	G1C101K00033	COIL	100UH	2
L2002	JOJBC0000009	FILTER		1
L2100	JOJBC0000009	FILTER		1
L2101, 02	JOJCC0000168	FERRITE BEAD CHIP		2
L3000-07	VLQ07821N0	COIL		8
L3008-13	JOJBC0000009	FILTER		6
L3200-09	JOJBC0000009	FILTER		10
L3300-05	VLQ07821N0	COIL		6
L3306-09	JOJBC0000009	FILTER		4
L3400, 01	G1C3N3Z00008	COIL	3.3UH	2
L3402	JOJBC0000009	FILTER		1
L3404	G1C6N8J00006	COIL	6.8UH	1
L3405	G1C3N3Z00008	COIL	3.3UH	1
L3407-12	JOJBC0000009	FILTER		6
L3413	G1C3N9Z00010	COIL	3.9UH	1
L3500, 01	JOJBC0000009	FILTER		2
L6000, 01	JOJBC0000009	FILTER		2
L6100	JOJBC0000009	FILTER		1
L6102, 03	JOJBC0000014	FILTER		2
L6105	JOJBC0000009	FILTER		1
L6106-20	JOJBC0000014	FILTER		15
L6202	JOJBC0000009	FILTER		1
L6300-04	JOJBC0000022	FILTER		5
L6306, 07	JOJBC0000022	FILTER		2
L6501	JOJBC0000009	FILTER		1
L6601, 02	VLP0147	COIL		2
L6603	JOJBC0000009	FILTER		1
P1000	K1KA05AA0409	CONNECTOR (MALE)		1
P1001, 02	K1KA06AA0409	CONNECTOR (MALE)		2
P1200	K1KA03A00150	CONNECTOR (MALE)		1
P1201	K1FA104A0012	CONNECTOR		1
P1202	K1KA02B00243	CONNECTOR (MALE)		1
P2001	K1FA104A0012	CONNECTOR		1
P2100, 01	K1KA02AA0229	CONNECTOR (MALE)		2
P3500	K1KB60A00143	CONNECTOR (FEMALE)		1
P6100, 01	K1FB109A0031	CONNECTOR (FEMALE)		2
P6103	K1FA106A0008	CONNECTOR (MALE)		1
P6600	K1KA20B00153	CONNECTOR (MALE)		1
Q1000	XN0440100L	TRANSISTOR		1
Q1001	2SD1820A0L	TRANSISTOR		1
Q1002	2SB1219A	TRANSISTOR		1
Q1003	XN0160100L	TRANSISTOR-RESISTOR		1
Q1004	B1DFGL000007	TRANSISTOR		1
Q1005	2SD1820A0L	TRANSISTOR		1
Q1006	2SD1819A-R	TRANSISTOR		1
Q1007	B1DHED000008	TRANSISTOR		1
Q1200-02	B1DGJG000006	TRANSISTOR		3
Q1203	XN0440100L	TRANSISTOR		1
Q1204	XN4501	TRANSISTOR-RESISTOR		1
Q1205	XN0440100L	TRANSISTOR		1
Q1206	XN0460100L	TRANSISTOR-RESISTOR		1
Q1207	B1DHED000008	TRANSISTOR		1
Q2101	2SB1219A	TRANSISTOR		1
Q3000	2SA153200L	TRANSISTOR		1
Q3001-06	2SC3930	TRANSISTOR		6
Q3007-11	2SA153200L	TRANSISTOR		5
Q3012-14	2SC3930	TRANSISTOR		3
Q3015	2SC3938-R	TRANSISTOR		1
				2SC39380RL

Ref.No.	Part No.	Part Name & Description	Pcs	Remarks
Q3016	2SC3930	TRANSISTOR	1	
Q3017-20	2SA153200L	TRANSISTOR	4	
Q3021, 22	2SC3930	TRANSISTOR	2	
Q3023	2SC3938-R	TRANSISTOR	1	2SC39380RL
Q3024-26	2SA153200L	TRANSISTOR	3	
Q3027-31	2SC3930	TRANSISTOR	5	
Q3032-36	2SA153200L	TRANSISTOR	5	
Q3037	2SC3938-R	TRANSISTOR	1	2SC39380RL
Q3038	2SC3930	TRANSISTOR	1	
Q3039	2SA153200L	TRANSISTOR	1	
Q3040, 41	2SC3930	TRANSISTOR	2	
Q3042	2SA153200L	TRANSISTOR	1	
Q3200-05	2SC3930	TRANSISTOR	6	
Q3400	B1MBCDA00004	TRANSISTOR	1	
Q3500	B1MBCDA00004	TRANSISTOR	1	
QR1001	UNR511200L	TRANSISTOR	1	
QR1002	UNR521100L	TRANSISTOR	1	
QR1004	UNR511300L	TRANSISTOR	1	
QR1005, 06	UNR521100L	TRANSISTOR	2	
QR1007	UNR511400L	TRANSISTOR-RESISTOR	1	
QR1008	UNR521400L	TRANSISTOR-RESISTOR	1	
QR1009, 10	UNR521100L	TRANSISTOR	2	
QR1200	UNR521100L	TRANSISTOR	1	
QR1201	UNR511300L	TRANSISTOR	1	
QR1202, 03	UN5212	TRANSISTOR-RESISTOR	2	
QR1204	UNR521100L	TRANSISTOR	1	
QR2000-08	UNR9214J0L	TRANSISTOR	9	
QR2009, 10	UNR521100L	TRANSISTOR	2	
QR2100-02	UNR9214J0L	TRANSISTOR	3	
QR3400	UNR9214J0L	TRANSISTOR	1	
QR3402, 03	UNR9215J0L	TRANSISTOR	2	
QR3500	UNR9214J0L	TRANSISTOR	1	
R1000, 01	ERJ3GEY0R00	M. RESISTOR CH 1/16W 0	2	
R1004	ERJ3RBD104	M. RESISTOR CH 1/16W 100K	1	
R1005	ERJL1WKJ39M	M. RESISTOR CH 1W	1	
R1006	ERJ3RBD821	M. RESISTOR CH 1/16W 820	1	
R1007	ERJ3RBD151	M. RESISTOR CH 1/16W 150	1	
R1008	ERJ3RBD102	M. RESISTOR CH 1/16W 1K	1	
R1009	ERJ2RHD473	M. RESISTOR CH 1/16W 47K	1	
R1011	ERJ2RHD273	M. RESISTOR CH 1/16W 27K	1	
R1012	ERJ2RHD333	M. RESISTOR CH 1/16W 33K	1	
R1013	ERJ2RHD123	M. RESISTOR CH 1/16W 12K	1	
R1014	ERJ3GEY0R00	M. RESISTOR CH 1/16W 0	1	
R1015	ERJ3GEYJ105	M. RESISTOR CH 1/16W 1M	1	
R1016	ERJ3GEYJ103	M. RESISTOR CH 1/16W 10K	1	
R1017	ERJ3RBD103	M. RESISTOR CH 1/16W 10K	1	
R1018	ERJL1WKJ10CU	M. RESISTOR CH 1W 1	1	
R1019	ERJ3RBD301	M. RESISTOR CH 1/16W 300	1	
R1020	ERJ3RBD471	M. RESISTOR CH 1/16W 470	1	
R1021	ERJ3RBD222	M. RESISTOR CH 1/16W 2.2K	1	
R1022	ERJ2RHD223	M. RESISTOR CH 1/16W 22K	1	
R1023	ERJ2RHD333	M. RESISTOR CH 1/16W 33K	1	
R1024, 25	ERJ2RHD223	M. RESISTOR CH 1/16W 22K	2	
R1026	ERJ2RHD123	M. RESISTOR CH 1/16W 12K	1	
R1027	ERJ3GEY0R00	M. RESISTOR CH 1/16W 0	1	
R1028	ERJ3GEYJ105	M. RESISTOR CH 1/16W 1M	1	
R1029	ERJ3GEYJ103	M. RESISTOR CH 1/16W 10K	1	
R1030	ERJ3RBD103	M. RESISTOR CH 1/16W 10K	1	
R1031	ERJL1WKJ10CU	M. RESISTOR CH 1W 1	1	
R1032	ERJ3RBD122	M. RESISTOR CH 1/16W 1.2K	1	
R1033	ERJ3RBD112	M. RESISTOR CH 1/16W 1.1K	1	
R1034	ERJ3RBD222	M. RESISTOR CH 1/16W 2.2K	1	
R1035	ERJ2RHD393	M. RESISTOR CH 1/16W 39K	1	
R1036	ERJ2RHD473	M. RESISTOR CH 1/16W 47K	1	
R1037	ERJ2RHD153	M. RESISTOR CH 1/16W 15K	1	
R1038	ERJ2RHD333	M. RESISTOR CH 1/16W 33K	1	
R1039	ERJ2RHD103	M. RESISTOR CH 1/16W 10K	1	
R1040	ERJ3GEYJ103	M. RESISTOR CH 1/16W 10K	1	
R1041	ERJ3RBD153	M. RESISTOR CH 1/16W 15K	1	
R1042	ERJ3RBD472	M. RESISTOR CH 1/16W 4.7K	1	
R1043	ERJ3RBD223	M. RESISTOR CH 1/16W 22K	1	
R1044, 45	ERJ3RBD333	M. RESISTOR CH 1/16W 33K	2	
R1046, 47	ERJ3RBD392	M. RESISTOR CH 1/16W 3.9K	2	

Ref.No.	Part No.	Part Name & Description	Pcs	Remarks
R1048, 49	ERJ3RBD333	M. RESISTOR CH 1/16W 33K	2	
R1050, 51	ERJ3RBD102	M. RESISTOR CH 1/16W 1K	2	
R1052	ERJ3RBD562	M. RESISTOR CH 1/16W 5.6K	1	
R1053	ERJ3RBD512	M. RESISTOR CH 1/16W 5.1K	1	
R1054	ERJ3GEYJ100	M. RESISTOR CH 1/16W 10	1	
R1055	ERJ3GEYJ153	M. RESISTOR CH 1/16W 15K	1	
R1056	ERJ3GEYJ333	M. RESISTOR CH 1/16W 33K	1	
R1057	ERJL14KJ50M	M. RESISTOR CH 1/4W 5	1	
R1058	ERJ3GEYJ100	M. RESISTOR CH 1/16W 10	1	
R1059	ERJ3GEYJ102	M. RESISTOR CH 1/16W 1K	1	
R1060	ERJ3GEYJ103	M. RESISTOR CH 1/16W 10K	1	
R1061	ERJ3GEYJ332	M. RESISTOR CH 1/16W 3.3K	1	
R1062	ERJ3GEYJ563	M. RESISTOR CH 1/16W 56K	1	
R1063	ERJ3GEYJ333	M. RESISTOR CH 1/16W 33K	1	
R1064	ERJ3GEYJ332	M. RESISTOR CH 1/16W 3.3K	1	
R1065	ERJ3GEYJ220	M. RESISTOR CH 1/16W 22	1	
R1066	ERJ3GEYJ104	M. RESISTOR CH 1/16W 100K	1	
R1067, 68	ERJ6GEYF472	M. RESISTOR CH 1/10W 4.7K	2	DOG472JA003
R1070	ERJ3GEYJ103	M. RESISTOR CH 1/16W 10K	1	
R1071	ERJ3RBD683	M. RESISTOR CH 1/16W 68K	1	
R1072	ERJ2RHD333	M. RESISTOR CH 1/16W 33K	1	
R1073	ERJ2GEJ563	M. RESISTOR CH 1/16W 56K	1	
R1075	ERJ2GEJ563	M. RESISTOR CH 1/16W 56K	1	
R1076	ERJ2RHD473	M. RESISTOR CH 1/16W 47K	1	
R1077	ERJ2RHD123	M. RESISTOR CH 1/16W 12K	1	
R1079	ERJ2GEJ224	M. RESISTOR CH 1/16W 220K	1	
R1080	ERJ2GEJ104	M. RESISTOR CH 1/16W 100K	1	
R1081	ERJ2GEJ473	M. RESISTOR CH 1/16W 47K	1	
R1083	ERJ3GEY0R00	M. RESISTOR CH 1/16W 0	1	
R1084	ERJ3GEYJ331	M. RESISTOR CH 1/16W 330	1	
R1085	ERJ3GEYJ103	M. RESISTOR CH 1/16W 10K	1	
R1086	ERJ3RBD472	M. RESISTOR CH 1/16W 4.7K	1	
R1087	ERJ3RED270	M. RESISTOR CH 1/16W 27	1	
R1088	ERJ3RBD104	M. RESISTOR CH 1/16W 100K	1	
R1089	ERJ3RED270	M. RESISTOR CH 1/16W 27	1	
R1090, 91	ERJ3RBD473	M. RESISTOR CH 1/16W 47K	2	
R1092	ERJ3RBD273	M. RESISTOR CH 1/16W 27K	1	
R1093	ERJ2GEJ103	M. RESISTOR CH 1/16W 10K	1	
R1094	ERJ3RBD563	M. RESISTOR CH 1/16W 56K	1	
R1095	ERJ6GEYJ477	M. RESISTOR CH 1/10W 4.7K	1	
R1096	ERJ3GEYJ221	M. RESISTOR CH 1/16W 220	1	
R1200	ERJ3GEYJ331	M. RESISTOR CH 1/16W 330	1	
R1201	ERJ3GEYJ102	M. RESISTOR CH 1/16W 1K	1	
R1203	ERJ3GEYJ473	M. RESISTOR CH 1/16W 47K	1	
R1204	ERJ6GEY0R00	M. RESISTOR CH 1/10W 0	1	DOYDR0000005
R1205	ERJ6GEYJ104	M. RESISTOR CH 1/10W 100K	1	
R1206-08	ERJ6GEYJ477	M. RESISTOR CH 1/10W 4.7K	3	
R1209	ERJ6GEYJ332	M. RESISTOR CH 1/10W 3.3K	1	DOG472JA003
R1210	ERJ6GEYJ104	M. RESISTOR CH 1/10W 100K	1	
R1211	VRE0222J33M	M. RESISTOR	1	
R1212	ERJ6GEYJ104	M. RESISTOR CH 1/10W 100K	1	
R1213	ERJ6GEYJ101	M. RESISTOR CH 1/10W 100	1	
R1214	ERJ6GEYJ103	M. RESISTOR CH 1/10W 10K	1	
R1215	ERJ6GEYJ182	M. RESISTOR CH 1/10W 1.8K	1	
R1216	ERJ6GEYJ103	M. RESISTOR CH 1/10W 10K	1	
R1217	VRE0222J10M	M. RESISTOR	1	
R1230	ERJ3RBD563	M. RESISTOR CH 1/16W 56K	1	
R1231	ERJ6GEYJ477	M. RESISTOR CH 1/10W 4.7K	1	
R1242	ERJ6GEYJ101	M. RESISTOR CH 1/10W 100	1	
R1243	ERJ6GEYJ182	M. RESISTOR CH 1/10W 1.8K	1	
R1256-58	ERJ3GEYJ473	M. RESISTOR CH 1/16W 47K	3	
R2001-13	ERJ2GEJ472	M. RESISTOR CH 1/16W 4.7K	13	
R2015-19	ERJ3GEYJ181	M. RESISTOR CH 1/16W 180	5	
R2020-23	ERJ3GEYJ391	M. RESISTOR CH 1/16W 390	4	
R2024	ERJ2GEJ472	M. RESISTOR CH 1/16W 4.7K	1	
R2025-28	ERJ2GEJ103	M. RESISTOR CH 1/16W 10K	4	
R2029	ERJ2GEJ472	M. RESISTOR CH 1/16W 4.7K	1	
R2030-33	ERJ2GEJ103	M. RESISTOR CH 1/16W 10K	4	
R2034	ERJ2GEJ472	M. RESISTOR CH 1/16W 4.7K	1	
R2035-38	ERJ2GEJ103	M. RESISTOR CH 1/16W 10K	4	
R2039	ERJ2GEJ472	M. RESISTOR CH 1/16W 4.7K	1	
R2040-43	ERJ2GEJ103	M. RESISTOR CH 1/16W 10K	4	
R2044, 45	ERJ6GEY0R00	M. RESISTOR CH 1/10W 0	2	DOYDR0000005
R2108, 09	ERJ2GEJ473	M. RESISTOR CH 1/16W 47K	2	
R2110-13	ERJ2GEJ472	M. RESISTOR CH 1/16W 4.7K	4	

Ref.No.	Part No.	Part Name & Description	Pcs	Remarks
R2114, 15	ERJ2GEJ103	M. RESISTOR CH 1/16W 10K	2	
R2116, 17	ERJ2GEJ182	M. RESISTOR CH 1/16W 1.8K	2	
R2118, 19	ERJ2GEJ152	M. RESISTOR CH 1/16W 1.5K	2	
R2127-30	ERJ2GEJ102	M. RESISTOR CH 1/16W 1K	4	
R2132	ERJ2GEJ223	M. RESISTOR CH 1/16W 22K	1	
R2133	ERJ2GEJ122	M. RESISTOR CH 1/16W 1.2K	1	
R2134	ERJ2GEJ103	M. RESISTOR CH 1/16W 10K	1	
R2135	ERJ2GEJ102	M. RESISTOR CH 1/16W 1K	1	
R2136	ERJ2GEOR00	M. RESISTOR CH 1/16W 0	1	
R2137, 38	ERJ2GEJ560	M. RESISTOR CH 1/16W 56	2	
R2142-47	ERJ2GEOR00	M. RESISTOR CH 1/16W 0	6	
R2148-51	ERJ2GEJ102	M. RESISTOR CH 1/16W 1K	4	
R2152, 53	ERJ2GEJ683	M. RESISTOR CH 1/16W 68K	2	
R2154-57	ERJ2GEJ102	M. RESISTOR CH 1/16W 1K	4	
R2158	ERJ2GEJ104	M. RESISTOR CH 1/16W 100K	1	
R2159	ERJ2GEJ103	M. RESISTOR CH 1/16W 10K	1	
R2162	ERJ2GEOR00	M. RESISTOR CH 1/16W 0	1	
R2165, 66	ERJ2GEJ330	M. RESISTOR CH 1/16W 33	2	
R2167	ERJ2GEOR00	M. RESISTOR CH 1/16W 0	1	
R3000-02	ERJ14NF75R0	M. RESISTOR CH 1/4W 75	3	
R3003, 04	ERJ2GEJ102	M. RESISTOR CH 1/16W 1K	2	
R3005-07	ERJ2GEJ101	M. RESISTOR CH 1/16W 100	3	
R3010, 11	ERJ2GEJ331	M. RESISTOR CH 1/16W 330	2	
R3012-14	ERJ2GEJ683	M. RESISTOR CH 1/16W 68K	3	
R3015, 16	ERJ2GEJ473	M. RESISTOR CH 1/16W 47K	2	
R3020-22	ERJ2GEOR00	M. RESISTOR CH 1/16W 0	3	
R3023	ERJ2GEJ332	M. RESISTOR CH 1/16W 3.3K	1	
R3024	ERJ2GEJ103	M. RESISTOR CH 1/16W 10K	1	
R3031	ERJ2GEJ103	M. RESISTOR CH 1/16W 10K	1	
R3032	ERJ2GEJ332	M. RESISTOR CH 1/16W 3.3K	1	
R3033-35	ERJ2GEJ103	M. RESISTOR CH 1/16W 10K	3	
R3036-44	ERJ2GEJ100	M. RESISTOR CH 1/16W 10	9	
R3045	ERJ2GEJ471	M. RESISTOR CH 1/16W 470	1	
R3046-49	ERJ2GEJ102	M. RESISTOR CH 1/16W 1K	4	
R3050	ERJ2GEJ101	M. RESISTOR CH 1/16W 100	1	
R3051	ERJ2GEJ151	M. RESISTOR CH 1/16W 150	1	
R3052-54	ERJ2GEJ221	M. RESISTOR CH 1/16W 220	3	
R3055	ERJ2GEJ101	M. RESISTOR CH 1/16W 100	1	
R3056	ERJ2GEJ151	M. RESISTOR CH 1/16W 150	1	
R3057-59	ERJ2GEJ221	M. RESISTOR CH 1/16W 220	3	
R3060	ERJ2GEJ103	M. RESISTOR CH 1/16W 10K	1	
R3061	ERJ2GEJ471	M. RESISTOR CH 1/16W 470	1	
R3062-65	ERJ2GEJ102	M. RESISTOR CH 1/16W 1K	4	
R3066	ERJ2RHD122	M. RESISTOR CH 1/16W 1.2K	1	
R3067	ERJ2GEJ103	M. RESISTOR CH 1/16W 10K	1	
R3068	ERJ2GEJ471	M. RESISTOR CH 1/16W 470	1	
R3069, 70	ERJ2GEJ102	M. RESISTOR CH 1/16W 1K	2	
R3071	ERJ2GEJ101	M. RESISTOR CH 1/16W 100	1	
R3072, 73	ERJ2GEJ221	M. RESISTOR CH 1/16W 220	2	
R3074	ERJ2RHD272	M. RESISTOR CH 1/16W 2.7K	1	
R3075	ERJ2GEJ102	M. RESISTOR CH 1/16W 1K	1	
R3076	ERJ2GEJ101	M. RESISTOR CH 1/16W 100	1	
R3077, 78	ERJ2GEJ221	M. RESISTOR CH 1/16W 220	2	
R3079	ERJ2GEJ103	M. RESISTOR CH 1/16W 10K	1	
R3080, 81	ERJ2GEJ680	M. RESISTOR CH 1/16W 68	2	
R3082	ERJ2GEJ102	M. RESISTOR CH 1/16W 1K	1	
R3083	ERJ2GEJ100	M. RESISTOR CH 1/16W 10	1	
R3084	ERJ2GEJ471	M. RESISTOR CH 1/16W 470	1	
R3085-87	ERJ2GEJ102	M. RESISTOR CH 1/16W 1K	3	
R3088	ERJ2RHD101	M. RESISTOR CH 1/16W 100	1	
R3089	ERJ2GEJ103	M. RESISTOR CH 1/16W 10K	1	
R3090	ERJ2GEJ471	M. RESISTOR CH 1/16W 470	1	
R3091	ERJ2RHD562	M. RESISTOR CH 1/16W 5.6K	1	
R3092	ERJ2RHD473	M. RESISTOR CH 1/16W 47K	1	
R3093	ERJ2GEJ561	M. RESISTOR CH 1/16W 560	1	
R3094	ERJ2GEJ103	M. RESISTOR CH 1/16W 10K	1	
R3095	ERJ2GEJ100	M. RESISTOR CH 1/16W 10	1	
R3096	ERJ2GEJ471	M. RESISTOR CH 1/16W 470	1	
R3097	ERJ2GEJ100	M. RESISTOR CH 1/16W 10	1	
R3098	ERJ2GEJ103	M. RESISTOR CH 1/16W 10K	1	
R3099	ERJ2GEJ100	M. RESISTOR CH 1/16W 10	1	
R3100	ERJ2GEJ221	M. RESISTOR CH 1/16W 220	1	
R3101	ERJ2GEJ100	M. RESISTOR CH 1/16W 10	1	
R3102	ERJ2GEJ471	M. RESISTOR CH 1/16W 470	1	
R3103-06	ERJ2GEJ102	M. RESISTOR CH 1/16W 1K	4	

Ref.No.	Part No.	Part Name & Description	Pcs	Remarks
R3107	ERJ2GEJ101	M. RESISTOR CH 1/16W 100	1	
R3108	ERJ2GEJ151	M. RESISTOR CH 1/16W 150	1	
R3109-11	ERJ2GEJ221	M. RESISTOR CH 1/16W 220	3	
R3112	ERJ2GEJ101	M. RESISTOR CH 1/16W 100	1	
R3113	ERJ2GEJ151	M. RESISTOR CH 1/16W 150	1	
R3114-16	ERJ2GEJ221	M. RESISTOR CH 1/16W 220	3	
R3117	ERJ2GEJ103	M. RESISTOR CH 1/16W 10K	1	
R3118	ERJ2GEJ471	M. RESISTOR CH 1/16W 470	1	
R3119-22	ERJ2GEJ102	M. RESISTOR CH 1/16W 1K	4	
R3123	ERJ2RHD122	M. RESISTOR CH 1/16W 1.2K	1	
R3124	ERJ2GEJ103	M. RESISTOR CH 1/16W 10K	1	
R3125	ERJ2RHD272	M. RESISTOR CH 1/16W 2.7K	1	
R3126	ERJ2GEJ102	M. RESISTOR CH 1/16W 1K	1	
R3127, 28	ERJ2GEJ680	M. RESISTOR CH 1/16W 68	2	
R3129	ERJ2GEJ102	M. RESISTOR CH 1/16W 1K	1	
R3130	ERJ2GEJ100	M. RESISTOR CH 1/16W 10	1	
R3131	ERJ2GEJ102	M. RESISTOR CH 1/16W 1K	1	
R3132	ERJ2GEJ471	M. RESISTOR CH 1/16W 470	1	
R3133	ERJ2GEJ103	M. RESISTOR CH 1/16W 10K	1	
R3134	ERJ2GEJ100	M. RESISTOR CH 1/16W 10	1	
R3135	ERJ2GEJ471	M. RESISTOR CH 1/16W 470	1	
R3136	ERJ2GEJ100	M. RESISTOR CH 1/16W 10	1	
R3137	ERJ2GEJ102	M. RESISTOR CH 1/16W 1K	1	
R3138	ERJ2GEJ331	M. RESISTOR CH 1/16W 330	1	
R3200-02	ERJ2GEOR00	M. RESISTOR CH 1/16W 0	3	
R3204	ERJ2GEJ222	M. RESISTOR CH 1/16W 2.2K	1	
R3205, 06	ERJ2GEJ102	M. RESISTOR CH 1/16W 1K	2	
R3207, 08	ERJ2GEJ472	M. RESISTOR CH 1/16W 4.7K	2	
R3209	ERJ2GEJ222	M. RESISTOR CH 1/16W 2.2K	1	
R3210	ERJ2GEJ102	M. RESISTOR CH 1/16W 1K	1	
R3211	ERJ2GEJ330	M. RESISTOR CH 1/16W 33	1	
R3213	ERJ2GEJ102	M. RESISTOR CH 1/16W 1K	1	
R3214	ERJ2GEJ822	M. RESISTOR CH 1/16W 8.2K	1	
R3215	ERJ2GEJ103	M. RESISTOR CH 1/16W 10K	1	
R3216-19	ERJ2GEJ100	M. RESISTOR CH 1/16W 10	4	
R3220, 21	EXBN8V103J	COMBI. R-R	10K	2
R3222	ERJ2GEJ102	M. RESISTOR CH 1/16W 1K	1	1
R3223, 24	EXBN8V330J	COMBI. R-R	33	2
R3225-27	ERJ2GEJ471	M. RESISTOR CH 1/16W 470	3	
R3228	ERJ2GEJ221	M. RESISTOR CH 1/16W 220	1	
R3233, 34	ERJ2GEJ152	M. RESISTOR CH 1/16W 1.5K	2	
R3235-42	ERJ2GEJ100	M. RESISTOR CH 1/16W 10	8	
R3243	EXBN8V103J	COMBI. R-R	10K	1
R3244	ERJ2GEJ101	M. RESISTOR CH 1/16W 100	1	
R3245	ERJ2GEJ680	M. RESISTOR CH 1/16W 68	1	
R3248	EXBN8V103J	COMBI. R-R	10K	1
R3252, 53	EXBN8V330J	COMBI. R-R	33	2
R3254	ERJ2RHD152	M. RESISTOR CH 1/16W 1.5K	1	
R3255	ERJ2GEJ152	M. RESISTOR CH 1/16W 1.5K	1	
R3258-60	EXBN8V103J	COMBI. R-R	10K	3
R3262	EXBN8V330J	COMBI. R-R	33	1
R3265, 66	EXBN8V330J	COMBI. R-R	33	2
R3267, 68	EXBN8V103J	COMBI. R-R	10K	2
R3269, 70	EXBN8V330J	COMBI. R-R	33	2
R3271-73	EXBN8V103J	COMBI. R-R	10K	3
R3274	EXBN8V330J	COMBI. R-R	33	1
R3275	EXBN8V103J	COMBI. R-R	10K	1
R3276	EXBN8V330J	COMBI. R-R	33	1
R3277	ERJ2GEJ103	M. RESISTOR CH 1/16W 10K	1	
R3278	ERJ2GEJ470	M. RESISTOR CH 1/16W 47	1	
R3279-82	ERJ2GEJ680	M. RESISTOR CH 1/16W 68	4	
R3283	EXBN8V330J	COMBI. R-R	33	1
R3284, 85	ERJ2GEJ472	M. RESISTOR CH 1/16W 4.7K	2	
R3286	ERJ2GEJ473	M. RESISTOR CH 1/16W 47K	1	
R3287	ERJ2GEOR00	M. RESISTOR CH 1/16W 0	1	
R3289	ERJ2GEJ103	M. RESISTOR CH 1/16W 10K	1	
R3300-02	ERJ14NF75R0	M. RESISTOR CH 1/4W 75	3	
R3303-05	ERJ2GEJ101	M. RESISTOR CH 1/16W 100	3	
R3306-08	ERJ2GEJ683	M. RESISTOR CH 1/16W 68K	3	
R3312-14	ERJ2GEOR00	M. RESISTOR CH 1/16W 0	3	
R3321-26	ERJ2GEJ221	M. RESISTOR CH 1/16W 220	6	
R3334-36	ERJ2GEOR00	M. RESISTOR CH 1/16W 0	3	
R3339-41	ERJ2GEJ470	M. RESISTOR CH 1/16W 47	3	
R3342-44	ERJ2GEJ151	M. RESISTOR CH 1/16W 150	3	
R3345	EXBN8V103J	COMBI. R-R	10K	1

Ref.No.	Part No.	Part Name & Description	Pcs	Remarks
R3346	ERJ2GEJ330	M. RESISTOR CH 1/16W 33	1	
R3348	ERJ2GEJ332	M. RESISTOR CH 1/16W 3.3K	1	
R3350	ERJ2GEJ332	M. RESISTOR CH 1/16W 3.3K	1	
R3351	ERJ2GEJ102	M. RESISTOR CH 1/16W 1K	1	
R3352-54	EXBN8V330J	COMBI. R-R	33	3
R3400-03	ERJ3GEYJ750	M. RESISTOR CH 1/16W 75	4	
R3404	ERJ3GEYJ390	M. RESISTOR CH 1/16W 39	1	
R3405	ERJ2GEJ473	M. RESISTOR CH 1/16W 47K	1	
R3406.07	ERJ2GEJ102	M. RESISTOR CH 1/16W 1K	2	
R3416-19	ERJ2GEJ222	M. RESISTOR CH 1/16W 2.2K	4	
R3421	ERJ2GE0R00	M. RESISTOR CH 1/16W 0	1	
R3423	ERJ2GEJ101	M. RESISTOR CH 1/16W 100	1	
R3425	ERJ2GEJ472	M. RESISTOR CH 1/16W 4.7K	1	
R3427	ERJ2GEJ222	M. RESISTOR CH 1/16W 2.2K	1	
R3429	ERJ2GEJ472	M. RESISTOR CH 1/16W 4.7K	1	
R3430	ERJ2GEJ271	M. RESISTOR CH 1/16W 270	1	
R3431-33	ERJ3GEYJ750	M. RESISTOR CH 1/16W 75	3	
R3434	ERJ2GE0R00	M. RESISTOR CH 1/16W 0	1	
R3435.36	ERJ2GEJ222	M. RESISTOR CH 1/16W 2.2K	2	
R3438	ERJ2GEJ222	M. RESISTOR CH 1/16W 2.2K	1	
R3439	ERJ2GE0R00	M. RESISTOR CH 1/16W 0	1	
R3440.41	ERJ2GEJ222	M. RESISTOR CH 1/16W 2.2K	2	
R3442	ERJ2RHD331X	M. RESISTOR CH 1/16W 330	1	
R3443.44	ERJ2RHD101	M. RESISTOR CH 1/16W 100	2	
R3445.46	ERJ2GEJ221	M. RESISTOR CH 1/16W 220	2	
R3447	ERJ2RHD221	M. RESISTOR CH 1/16W 220	1	
R3448	ERJ2RHD102	M. RESISTOR CH 1/16W 1K	1	
R3456	ERJ2RHD102	M. RESISTOR CH 1/16W 1K	1	
R3457-60	EXBN8V103J	COMBI. R-R	10K	4
R3461	ERJ2GEJ103	M. RESISTOR CH 1/16W 10K	1	
R3462	EXBN8V330J	COMBI. R-R	33	1
R3463-65	EXBN8V103J	COMBI. R-R	10K	3
R3466.67	ERJ2GEJ100	M. RESISTOR CH 1/16W 10	2	
R3468.69	ERJ2GEJ330	M. RESISTOR CH 1/16W 33	2	
R3500	ERJ2GEJ473	M. RESISTOR CH 1/16W 47K	1	
R3501	ERJ2GEJ102	M. RESISTOR CH 1/16W 1K	1	
R3504-06	ERJ2GEJ472	M. RESISTOR CH 1/16W 4.7K	3	
R3508	ERJ2GEJ472	M. RESISTOR CH 1/16W 4.7K	1	
R3510	ERJ2GEJ330	M. RESISTOR CH 1/16W 33	1	
R3511	EXBN8V330J	COMBI. R-R	33	1
R3512	ERJ2GEJ103	M. RESISTOR CH 1/16W 10K	1	
R3517	EXBN8V103J	COMBI. R-R	10K	1
R3518-23	EXBN8V330J	COMBI. R-R	33	6
R3524-29	EXBN8V103J	COMBI. R-R	10K	6
R3530	ERJ2GEJ221	M. RESISTOR CH 1/16W 220	1	
R6000-04	EXBN8V103J	COMBI. R-R	10K	5
R6005	EXB24V560J	COMBI. R-R	56	1
R6006	EXB24V103J	COMBI. R-R	10K	1
R6007	ERJ2GEJ103	M. RESISTOR CH 1/16W 10K	1	
R6008	ERJ2GEJ102	M. RESISTOR CH 1/16W 1K	1	
R6009	ERJ2GEJ103	M. RESISTOR CH 1/16W 10K	1	
R6011-13	EXBN8V103J	COMBI. R-R	10K	3
R6014	EXB24V470J	COMBI. R-R	47	1
R6015	EXB24V100J	COMBI. R-R	10	1
R6016	EXBN8V330J	COMBI. R-R	33	1
R6017-21	EXBN8V100JX	COMBI. R-R	10	5
R6022	ERJ2GEJ102	M. RESISTOR CH 1/16W 1K	1	
R6023	EXBN8V100JX	COMBI. R-R	10	1
R6024	EXBN8V330J	COMBI. R-R	33	1
R6025-27	EXBN8V100JX	COMBI. R-R	10	3
R6029	ERJ2GEJ330	M. RESISTOR CH 1/16W 33	1	
R6030	ERJ2GEJ103	M. RESISTOR CH 1/16W 10K	1	
R6031-36	EXBN8V103J	COMBI. R-R	10K	6
R6037	ERJ2GEJ103	M. RESISTOR CH 1/16W 10K	1	
R6038-40	EXBN8V100JX	COMBI. R-R	10	3
R6041	ERJ2GEJ220	M. RESISTOR CH 1/16W 22	1	
R6042-45	ERJ2GEJ103	M. RESISTOR CH 1/16W 10K	4	
R6053	ERJ2GEJ103	M. RESISTOR CH 1/16W 10K	1	
R6054	EXB24V472J	COMBI. R-R	4.7K	1
R6055	ERJ2GEJ103	M. RESISTOR CH 1/16W 10K	1	
R6056.57	EXBN8V330J	COMBI. R-R	33	2
R6058.59	ERJ2GEJ103	M. RESISTOR CH 1/16W 10K	2	
R6060	ERJ2GEJ470	M. RESISTOR CH 1/16W 47	1	
R6067	ERJ2GEJ103	M. RESISTOR CH 1/16W 10K	1	
R6068	EXB24V472J	COMBI. R-R	4.7K	1

Ref.No.	Part No.	Part Name & Description	Pcs	Remarks
R6069	EXBN8V103J	COMBI. R-R	10K	1
R6070	EXB24V103J	COMBI. R-R	10K	1
R6072	ERJ2GEJ470	M. RESISTOR CH 1/16W 47	1	
R6073	EXBN8V103J	COMBI. R-R	10K	1
R6074	EXB24V103J	COMBI. R-R	10K	1
R6075	ERJ2GEJ223	M. RESISTOR CH 1/16W 22K	1	
R6078	ERJ2GEJ333	M. RESISTOR CH 1/16W 33K	1	
R6079	ERJ2GEJ103	M. RESISTOR CH 1/16W 10K	1	
R6081-83	EXBN8V103J	COMBI. R-R	10K	3
R6084-86	ERJ2GEJ103	M. RESISTOR CH 1/16W 10K	3	
R6088	ERJ2GEJ103	M. RESISTOR CH 1/16W 10K	1	
R6089	ERJ2GEJ102	M. RESISTOR CH 1/16W 1K	1	
R6090	ERJ2GEJ470	M. RESISTOR CH 1/16W 47	1	
R6091	ERJ2GEJ102	M. RESISTOR CH 1/16W 1K	1	
R6092	ERJ2GEJ103	M. RESISTOR CH 1/16W 10K	1	
R6093.94	ERJ2GEJ330	M. RESISTOR CH 1/16W 33	2	
R6100.01	ERJ2GE0R00	M. RESISTOR CH 1/16W 0	2	
R6102-05	ERJ2GEJ100	M. RESISTOR CH 1/16W 10	4	
R6106-13	ERJ2GEJ103	M. RESISTOR CH 1/16W 10K	8	
R6115	ERJ2GEJ330	M. RESISTOR CH 1/16W 33	1	
R6117	ERJ2GEJ222	M. RESISTOR CH 1/16W 2.2K	1	
R6119	ERJ2GE0R00	M. RESISTOR CH 1/16W 0	1	
R6122-26	ERJ2RHD102	M. RESISTOR CH 1/16W 1K	5	
R6200.01	ERJ2GE0R00	M. RESISTOR CH 1/16W 0	2	
R6202	ERJ2GEJ102	M. RESISTOR CH 1/16W 1K	1	
R6206-11	ERJ2GEJ102	M. RESISTOR CH 1/16W 1K	6	
R6214.15	EXBN8V330J	COMBI. R-R	33	2
R6216.17	ERJ2GE0R00	M. RESISTOR CH 1/16W 0	2	
R6300.01	ERJ3GEYOR00	M. RESISTOR CH 1/16W 0	2	
R6302-07	EXBN8V330J	COMBI. R-R	33	6
R6308	ERJ2GE0R00	M. RESISTOR CH 1/16W 0	1	
R6309-11	ERJ2GEJ330	M. RESISTOR CH 1/16W 33	3	
R6312-17	EXBN8V330J	COMBI. R-R	33	6
R6318	ERJ2GE0R00	M. RESISTOR CH 1/16W 0	1	
R6319-21	ERJ2GEJ330	M. RESISTOR CH 1/16W 33	3	
R6322.23	ERJ2GEJ472	M. RESISTOR CH 1/16W 4.7K	2	
R6324.25	EXBN8V472J	COMBI. R-R	4.7K	2
R6326-28	EXBN8V330J	COMBI. R-R	33	3
R6329.30	ERJ2GEJ102	M. RESISTOR CH 1/16W 1K	2	
R6331.32	ERJ6GEYG102	M. RESISTOR CH 1/10W 1K	2	
R6333	ERJ2GE0R00	M. RESISTOR CH 1/16W 0	1	
R6334.35	ERJ6GEYG102	M. RESISTOR CH 1/10W 1K	2	
R6336.37	ERJ2GE0R00	M. RESISTOR CH 1/16W 0	2	
R6338	ERJ2GEJ472	M. RESISTOR CH 1/16W 4.7K	1	
R6339-45	D1HG3908A002	COMBI. R-R	39	7
R6346	EXBN8V472J	COMBI. R-R	4.7K	1
R6347	ERJ2GE0R00	M. RESISTOR CH 1/16W 0	1	
R6349	ERJ2GEJ103	M. RESISTOR CH 1/16W 10K	1	
R6353.54	ERJ2GEJ103	M. RESISTOR CH 1/16W 10K	2	
R6355-57	ERJ2GEJ470	M. RESISTOR CH 1/16W 47	3	
R6358.59	ERJ2GEJ472	M. RESISTOR CH 1/16W 4.7K	2	
R6363-65	ERJ2GEJ472	M. RESISTOR CH 1/16W 4.7K	3	
R6368-70	ERJ2GEJ472	M. RESISTOR CH 1/16W 4.7K	3	
R6374	ERJ2GEJ102	M. RESISTOR CH 1/16W 1K	1	
R6375	ERJ3GEYOR00	M. RESISTOR CH 1/16W 0	1	
R6376	ERJ3RED105	M. RESISTOR CH 1/16W 1M	1	
R6377	ERJ2GEJ472	M. RESISTOR CH 1/16W 4.7K	1	
R6378	ERJ2GE0R00	M. RESISTOR CH 1/16W 0	1	
R6379.80	ERJ2GEJ472	M. RESISTOR CH 1/16W 4.7K	2	
R6381-88	EXBN8V330J	COMBI. R-R	33	8
R6389.90	ERJ2GEJ330	M. RESISTOR CH 1/16W 33	2	
R6393	ERJ2GEJ472	M. RESISTOR CH 1/16W 4.7K	1	
R6394	ERJ3RBD102	M. RESISTOR CH 1/16W 1K	1	
R6395	ERJ2GEJ330	M. RESISTOR CH 1/16W 33	1	
R6396	ERJ3RBD102	M. RESISTOR CH 1/16W 1K	1	
R6397	ERJ2GEJ102	M. RESISTOR CH 1/16W 1K	1	
R6398-09	EXB38V620JV	COMBI. R-R	62	12
R6410-16	ERJ3GEYJ620	M. RESISTOR CH 1/16W 62	7	
R6417.18	ERJ2GEJ102	M. RESISTOR CH 1/16W 1K	2	
R6500.01	ERJ2GE0R00	M. RESISTOR CH 1/16W 0	2	
R6502-06	ERJ2GEJ100	M. RESISTOR CH 1/16W 10	5	
R6507.08	ERJ2GEJ103	M. RESISTOR CH 1/16W 10K	2	
R6512	ERJ2GE0R00	M. RESISTOR CH 1/16W 0	1	
R6513.14	ERJ2GEJ330	M. RESISTOR CH 1/16W 33	2	
R6515	ERJ2GE0R00	M. RESISTOR CH 1/16W 0	1	

Components identified with the mark Δ have the special characteristics for safety. When replacing any of these components, use only the same type.

Ref.No.	Part No.	Part Name & Description	Pcs	Remarks
R6516, 17	ERJ2GEJ103	M. RESISTOR CH 1/16W 10K	2	
R6600-05	EXBN8V330J	COMBI. R-R	33	6
R6606-09	ERJ2GEJ330	M. RESISTOR CH 1/16W 33	4	
R6610	ERJ2GE0R00	M. RESISTOR CH 1/16W 0	1	
R6611	ERJ2GEJ472	M. RESISTOR CH 1/16W 4.7K	1	
RY3402, 03	K6D1CCA00002	RELAY	2	
SW2000-10	EVQ21K07K	SWITCH	11	
SW6100	VSS0367-08B	SWITCH	1	KOD191A0001
T1000	VLTO925	TRANSFORMER	1	G4ZZ00000377
TP1000-04	EYF6CU	TEST POINT	5	
TP3000	EYF6CU	TEST POINT	1	
TP3200, 01	EYF6CU	TEST POINT	2	
TP3300	EYF6CU	TEST POINT	1	
TP6000	EYF6CU	TEST POINT	1	
TP6206	EYF6CU	TEST POINT	1	
TP6302	EYF6CU	TEST POINT	1	
TP6500	EYF6CU	TEST POINT	1	
VR2000-03	EVEVCGJL016B	V. RESISTOR	0.16	4
VR2100	EVJ02BF01B53	V. RESISTOR	5K	1
X3200	HOJ286500009	CRYSTAL OSCILLATOR	1	
X3300	HOJ245500014	CRYSTAL OSCILLATOR	1	
X3400	H4G1487B0003	CRYSTAL OSCILLATOR	1	H4G1487B0002
X6000	H1A4805B0013	CRYSTAL OSCILLATOR	1	
X6300	HOJ200500038	CRYSTAL OSCILLATOR	1	
		MISCELLANEOUS		
VSC5786	SD1 BNC EARTH FRAME		1	
VGU6484	BUTTON		1	
VMP8511	BACK CASE COVER		1	
VMS4992	PIN		3	
VMX3514	VR KNOB SPACER		1	
VGU9566	ROTARY KNOB		4	
VJF1511	CLAMPLER		2	
VMP5301	D SUB HOLDER ANGLE		2	
VMP7834	S TERMINAL EARTH ANGLE		2	
VMP8515	SD1 BNC FRAME		1	
XYN3+J6FJ	SCREW		3	
Δ VMZ3624	BACK CASE COVER SHEET		1	
XSB3+6FJ	SCREW		3	
C3FBND000172	IC		1	
■ E2	VEP11117A	POWER P. C. BOARD	1	(RTL)
Δ C1002	ECQU2A224ML	P. CAPACITOR 100V 0.22U	1	
Δ C1004	ECQU2A224ML	P. CAPACITOR 100V 0.22U	1	
Δ C1005, 06	F1BAH4710001	C. CAPACITOR 470P	2	
C1009	EETHC2W221L	E. CAPACITOR 450V 220U	1	
C1010	ECQE6473KF	P. CAPACITOR 630V 0.047U	1	
C1011	F1H1H104A783	C. CAPACITOR CH 50V 0.1U	1	
C1012	ECUM1E224KBN	C. CAPACITOR CH 25V 0.22U	1	
C1013	ECUX1E105KBM	C. CAPACITOR CH 25V 1U	1	
C1014	ECUM1E224KBN	C. CAPACITOR CH 25V 0.22U	1	
C1015	VCKO106K101	C. CAPACITOR 100P	1	F1B3D101A002
C1016	EEUEB1H470B	E. CAPACITOR 50V 47U	1	
C1017	F1H1H104A783	C. CAPACITOR CH 50V 0.1U	1	
C1018	ECUX1H102KBV	C. CAPACITOR CH 50V 1000P	1	
C1019	F1H1H104A783	C. CAPACITOR CH 50V 0.1U	1	
C1020	ECUX1H102JCV	C. CAPACITOR CH 50V 1000P	1	
Δ C1024	VCKO262M222A	C. CAPACITOR 2200P	1	F1BAH2220002
C1202	F1H1H104A783	C. CAPACITOR CH 50V 0.1U	1	
C1204	F1K2J101A017	C. CAPACITOR CH 63V 100P	1	
C1206, 07	EEUFM1E152B	E. CAPACITOR 25V 1500U	2	
C1208	F1H1H104A783	C. CAPACITOR CH 50V 0.1U	1	

Ref.No.	Part No.	Part Name & Description	Pcs	Remarks
C1209, 10	EEUEB1E101B	E. CAPACITOR 25V 100U	2	
C1215-17	F1H1H104A783	C. CAPACITOR CH 50V 0.1U	3	
D1001	BOJBSL000020	DIODE	1	
D1002	MAZ82700ML	DIODE	1	
D1003	BOEAEV000004	DIODE	1	
D1004, 05	SFPL-52	DIODE	2	BOJCLM000001
D1006	MA8051-M	DIODE	1	MAZ80510ML
D1009	SFPB-54	DIODE	1	BOJCMC000002
D1010	BOJCLM000001	DIODE	1	
D1201	BOEBNR000035	DIODE	1	
D1202	MAZ81600HL	DIODE	1	
Δ F1001	VSF0106C25H	FUSE	1	
FH1, H2	EYF52BCY	FUSE HOLDER	2	
IC1001	CODABZG000005	IC	1	
IC1201	CODAEJC000006	IC	1	
JP1001	K4ZZ01000206	TERMINAL	1	
JP1003, 04	K4ZZ01000206	TERMINAL	2	
Δ L1001, 02	ELF19N016A	COIL	2	
L1003	VLP0364	CHIP INDUCTOR	1	JOJJC0000005
L1201, 02	GOA220H00018	COIL 22UH	2	
L1203, 04	VLP0394	FERRITE BEAD	2	JOKE00000032
P1001	K1KA02A00593	CONNECTOR (MALE)	1	
P1201	K1KA06AA0410	CONNECTOR (MALE)	1	
P1202	K1KA05AA0410	CONNECTOR (MALE)	1	
Q1001	B1DEFV000002	TRANSISTOR	1	
Δ Q1002, 03	B3QAZ0000071	PHOTO COUPLER	2	
QR1001	UN2111	TRANSISTOR-RESISTOR	1	
QR1201	UN2111	TRANSISTOR-RESISTOR	1	
QR1203	UN2214	TRANSISTOR-RESISTOR	1	UNR221400L
R1001, 02	ERJ12YJ394	M. RESISTOR CH 1/2W 390K	2	
R1003, 04	ERJ12YJ224	M. RESISTOR CH 1/2W 220K	2	
R1005	ERG3SJ104	M. RESISTOR 3W 100K	1	
R1006	ERJ6GEYG104	M. RESISTOR CH 1/10W 100K	1	
R1007	ERJ6RBD221	M. RESISTOR CH 1/10W 220	1	
R1008	ERX2SZJR15	M. RESISTOR 2W 0.15	1	
R1009, 10	ERJ14YJ100	M. RESISTOR CH 1/4W 100	2	
R1011	ERJ14YJ101	M. RESISTOR CH 1/4W 100	1	
R1012	ERJ3GEYJ223	M. RESISTOR CH 1/16W 22K	1	
R1015	ERJ3RBD433	M. RESISTOR CH 1/16W 43K	1	
R1016	ERJ3GEYG152	M. RESISTOR CH 1/16W 1.5K	1	
R1017	ERJ3RBD102	M. RESISTOR CH 1/16W 1K	1	
Δ R1018	ERC12AGM334C	S. RESISTOR 1/2W 33K	1	
R1019, 20	ERJ12YJ224	M. RESISTOR CH 1/2W 220K	2	
R1021	ERJ6GEYG563	M. RESISTOR CH 1/10W 56K	1	
R1022	ERG2SJ151	M. RESISTOR 2W 150	1	
R1201	ERJ3GEYG471	M. RESISTOR CH 1/16W 470	1	
R1202	ERJ3GEYJ681	M. RESISTOR CH 1/16W 680	1	
R1203	ERJ3GEYG102	M. RESISTOR CH 1/16W 1K	1	
R1204	ERJ3RBD622	M. RESISTOR CH 1/16W 6.2K	1	
R1205	ERJ3RBD182	M. RESISTOR CH 1/16W 1.8K	1	
R1207	ERJ3GEYJ101	M. RESISTOR CH 1/16W 100	1	
R1208	ERJ3GEYJ102	M. RESISTOR CH 1/16W 1K	1	
R1211	ERJ3GEYJ103	M. RESISTOR CH 1/16W 10K	1	
R1212	ERJ3RBD163	M. RESISTOR CH 1/16W 16K	1	
R1213	ERJ3GEYJ103	M. RESISTOR CH 1/16W 10K	1	
R1214	ERJ3GEYJ222	M. RESISTOR CH 1/16W 2.2K	1	
Δ T1001	ETS28BF1V5AD	TRANSFORMER	1	
TH1001	D4CAC5R10001	THERMISTOR	1	
		MISCELLANEOUS		
	VMZ2919	BARRIER	1	
	VMP8516	POWER HEAT SINK A	1	

CASING PARTS ASSEMBLY (BT-YAE1700G)

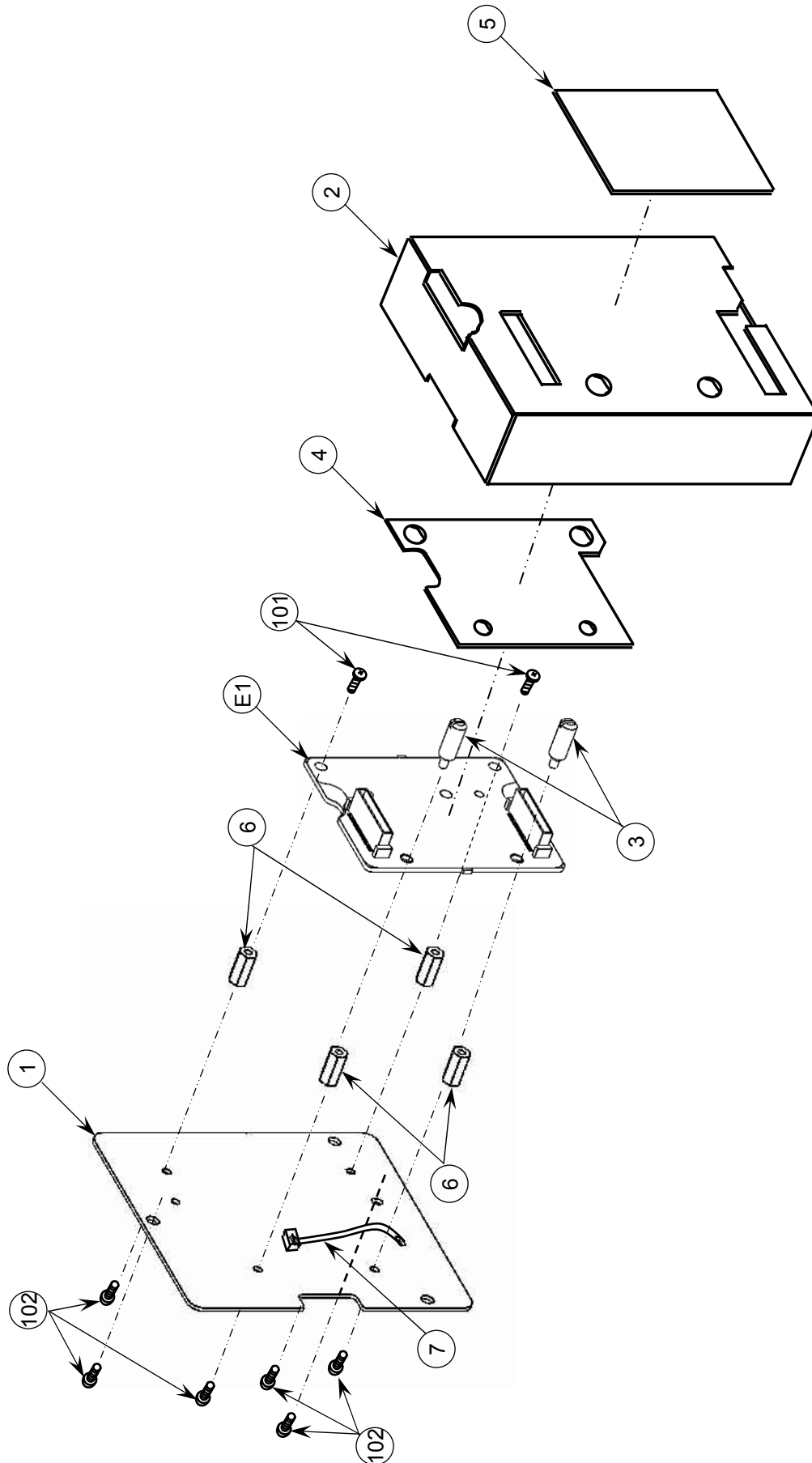

PACKING PARTS (BT-YAE1700G)

Components identified with the mark  have the special characteristics for safety. When replacing any of these components, use only the same type.

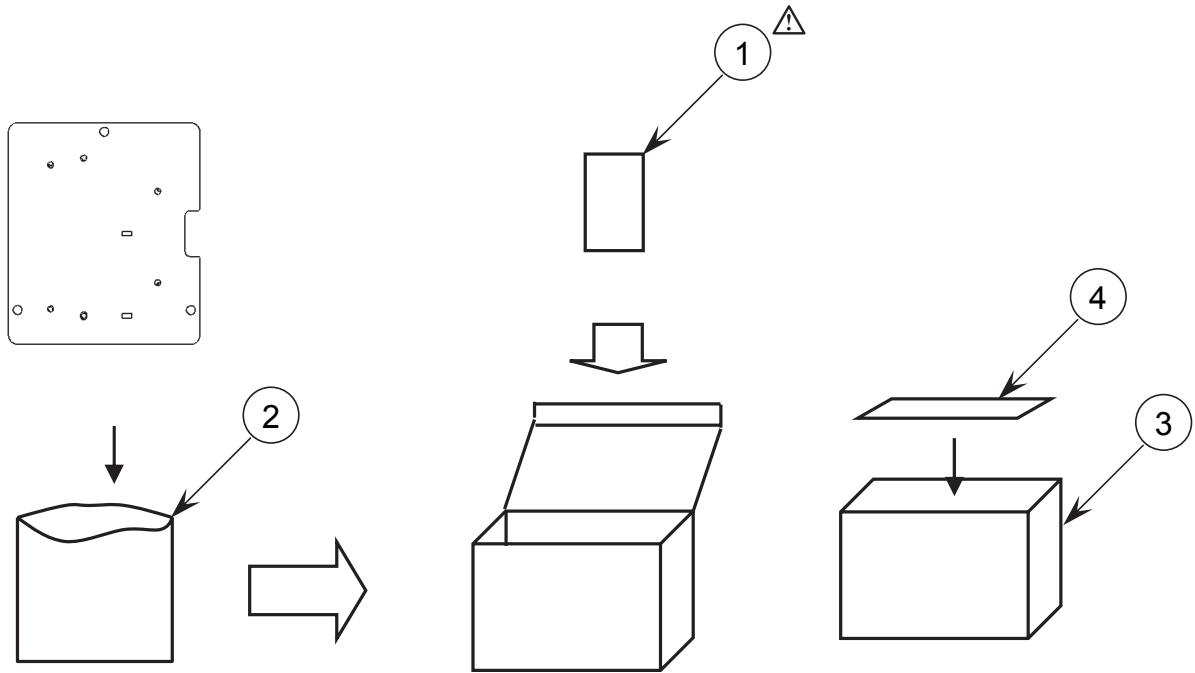

Ref.No.	Part No.	Part Name & Description	Pcs	Remarks	Ref.No.	Part No.	Part Name & Description	Pcs	Remarks
 1	VQTOU72	OPERATING INSTRUCTIONS	1						
2	VPF0678	AIR CAP	1						
3	VPG3121	PACKING CASE	1						
4	VQL1H36	PACKING LABEL	1						

ELECTRICAL REPLACEMENT PARTS LIST (BT-YAE1700G)

Ref.No.	Part No.	Part Name & Description	Pcs	Remarks	Ref.No.	Part No.	Part Name & Description	Pcs	Remarks
■ E1	VEP14101A	ENBE AUDIO P. C. BOARD	1	(RTL)	R4000-07	ERJ3GEY0R00	M. RESISTOR CH 1/16W 0	8	
					R4008-11	ERJ2GE0R00	M. RESISTOR CH 1/16W 0	4	
					R4012-15	ERJ2GEJ101	M. RESISTOR CH 1/16W 100	4	
					R4100	ERJ2GE0R00	M. RESISTOR CH 1/16W 0	1	
					R4101	ERJ2GEJ683	M. RESISTOR CH 1/16W 68K	1	
					R4102, 03	ERJ2GEJ103	M. RESISTOR CH 1/16W 10K	2	
					R4104	ERJ2GEJ473	M. RESISTOR CH 1/16W 47K	1	
					R4106, 07	ERJ2GE0R00	M. RESISTOR CH 1/16W 0	2	
					R4109	ERJ2GE0R00	M. RESISTOR CH 1/16W 0	1	
					R4110	ERJ2GEJ102	M. RESISTOR CH 1/16W 1K	1	
					R4114	ERJ2GEJ102	M. RESISTOR CH 1/16W 1K	1	
					R4115	ERJ2GEJ222	M. RESISTOR CH 1/16W 2.2K	1	
■ E1	VEP14101A	ENBE AUDIO P. C. BOARD	1	(RTL)	R4121, 22	ERJ2GEJ330	M. RESISTOR CH 1/16W 33	2	
					R4123	ERJ2GE0R00	M. RESISTOR CH 1/16W 0	1	
C4001, 02	ECJ0EB1A104K	C. CAPACITOR CH 10V 0.1U	2		R4200	ERJ2GEJ103	M. RESISTOR CH 1/16W 10K	1	
C4003, 04	ECJ3YBOJ226M	C. CAPACITOR CH6.3V 22U	2		R4201, 02	ERJ2GE0R00	M. RESISTOR CH 1/16W 0	2	
C4007	ECJ0EB1A104K	C. CAPACITOR CH 10V 0.1U	1		R4204-07	ERJ2GEJ103	M. RESISTOR CH 1/16W 10K	4	
C4008	ECJ3YBOJ226M	C. CAPACITOR CH6.3V 22U	1		R4208	ERJ2GEJ101	M. RESISTOR CH 1/16W 100	1	
C4009	ECJ0EB1A104K	C. CAPACITOR CH 10V 0.1U	1		R4209-12	ERJ2GEJ103	M. RESISTOR CH 1/16W 10K	4	
C4010	ECJ3YBOJ226M	C. CAPACITOR CH6.3V 22U	1		R4214-18	ERJ2GEJ103	M. RESISTOR CH 1/16W 10K	5	
C4100-02	ECJ0EB1A104K	C. CAPACITOR CH 10V 0.1U	3		R4220	EXBN8V103J	COMBI. R-R 10K	1	
C4103, 04	F1J1A335A003	C. CAPACITOR CH 10V 3.3U	2		R4221	ERJ2GEJ330	M. RESISTOR CH 1/16W 33	1	
C4105, 06	ECJ1VB1C105K	C. CAPACITOR CH 16V 1U	2		R4222	EXBN8V330J	COMBI. R-R 33	1	
C4107, 08	ECJ0EB1A104K	C. CAPACITOR CH 10V 0.1U	2		R4223, 24	ERJ2GEJ102	M. RESISTOR CH 1/16W 1K	2	
C4111	ECJ1VB1C105K	C. CAPACITOR CH 16V 1U	1		R4225, 26	EXBN8V330J	COMBI. R-R 33	2	
C4113	ECJ1VB1C105K	C. CAPACITOR CH 16V 1U	1		R4227	ERJ2RHD331X	M. RESISTOR CH 1/16W 330	1	
C4114, 15	ECJ0EB1A104K	C. CAPACITOR CH 10V 0.1U	2		R4229, 30	ERJ2RHD101	M. RESISTOR CH 1/16W 100	2	
C4116	ECJ2FBOJ106K	C. CAPACITOR CH 50V 10U	1		R4233	EXBN8V330J	COMBI. R-R 33	1	
C4118	ECJ0EB1C223	C. CAPACITOR CH 16V 0.022P	1		R4236	ERJ2RHD101	M. RESISTOR CH 1/16W 100	1	
C4119, 20	ECJ0EB1A104K	C. CAPACITOR CH 10V 0.1U	2		R4237	ERJ2RHD102	M. RESISTOR CH 1/16W 1K	1	
C4121, 22	ECJ0EC1H101J	C. CAPACITOR CH 50V 100P	2		R4238-40	ERJ2GEJ330	M. RESISTOR CH 1/16W 33	3	
C4123	ECJ1VB1C105K	C. CAPACITOR CH 16V 1U	1		R4241	ERJ2GEJ470	M. RESISTOR CH 1/16W 47	1	
C4125	ECJ1VB1C105K	C. CAPACITOR CH 16V 1U	1		R4242	ERJ2RHD102	M. RESISTOR CH 1/16W 1K	1	
C4127, 28	ECJ0EC1H101J	C. CAPACITOR CH 50V 100P	2		R4243	ERJ2GEJ103	M. RESISTOR CH 1/16W 10K	1	
C4129, 30	ECJ0EB1A104K	C. CAPACITOR CH 10V 0.1U	2		R4245-48	ERJ2GEJ103	M. RESISTOR CH 1/16W 10K	4	
C4131	ECJ2FBOJ106K	C. CAPACITOR CH 50V 10U	1		R4249	ERJ2GEJ102	M. RESISTOR CH 1/16W 1K	1	
C4202	ECJ0EB1A104K	C. CAPACITOR CH 10V 0.1U	1						
C4203	ECJ3YBOJ226M	C. CAPACITOR CH6.3V 22U	1						
C4205-07	ECJ2FBOJ106K	C. CAPACITOR CH 50V 10U	3		TP4100, 01	EYF6CU	TEST POINT	2	
C4208-20	ECJ0EB1A104K	C. CAPACITOR CH 10V 0.1U	13		TP4200	EYF6CU	TEST POINT	1	
C4221-26	ECJ0EB1E103K	C. CAPACITOR CH 25V 0.01U	6						
C4227	ECJ0EB1A104K	C. CAPACITOR CH 10V 0.1U	1						
C4228-33	ECJ0EB1E103K	C. CAPACITOR CH 25V 0.01U	6						
C4234, 35	ECJ0EB1A104K	C. CAPACITOR CH 10V 0.1U	2						
C4236	ECJ2FBOJ106K	C. CAPACITOR CH 50V 10U	1						
C4237	EEFCDOJ470	E. CAPACITOR 6.3V 47U	1						
C4239	ECJ0EB1A104K	C. CAPACITOR CH 10V 0.1U	1						
C4240	ECJ0EB1H102K	C. CAPACITOR CH 50V 1000P	1						
C4241	EEFCDOJ470	E. CAPACITOR 6.3V 47U	1						
C4243	ECJ0EB1A104K	C. CAPACITOR CH 10V 0.1U	1						
D4100, 01	MA3J14300L	DIODE	2						
FL4200, 01	F1HOJ4740004	C. CAPACITOR CH6.3V 0.47U	2						
IC4000	COFBBK000029	IC	1						
IC4100	TLC272CPW	IC	1	COABHA000022					
IC4101	COBCBD000029	IC	1						
IC4102	TLC29331PW	IC	1	COABFA000012					
IC4103, 04	COBCBD000029	IC	2						
IC4105	COZBZ0000830	IC	1						
IC4200	C1ZBZ0002497	IC	1						
IC4201, 02	COCBAYF00018	IC	2						
IC4203	C1ZBZ0002561	IC	1						
ID2	VVVS14543C	SOFTWARE	1	DOWNLOAD ONLY					
L4000, 01	JOJKC0000009	FILTER	2						
L4100-02	JOJKC0000009	FILTER	3						
L4104	JOJKC0000009	FILTER	1						
L4200	JOJKC0000009	FILTER	1						
P4000	K1KB60A00135	CONNECTOR (MALE)	1						
P4200	K1KA08BA0081	CONNECTOR (MALE)	1						